

ENGLISH



## 3D20 Quick Start Guide

**▲ WARNING**

**READ ALL OPERATING/SAFETY INSTRUCTIONS IN THE MANUAL AND FAMILIARIZE YOURSELF WITH THE DREMEL 3D20 BEFORE SETUP AND USE. FAILURE TO COMPLY WITH THE WARNINGS AND INSTRUCTIONS MAY RESULT IN FIRE, EQUIPMENT DAMAGE, PROPERTY DAMAGE, OR PERSONAL INJURY.**

# 1

## Unboxing

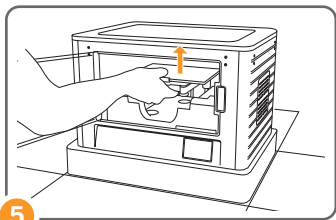
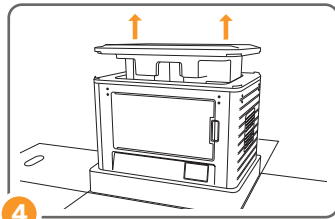
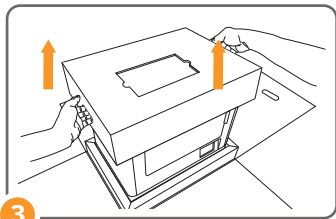
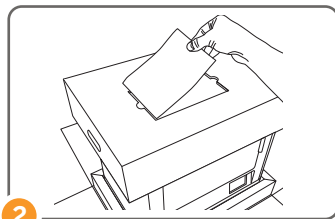
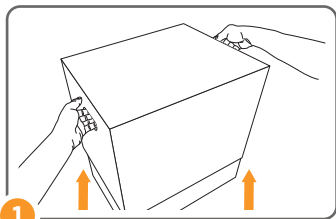

5 Firmly lift the build platform to the top position

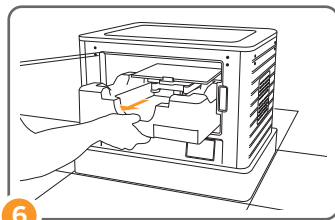

# 2

## Kit Contents

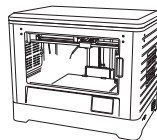

Dremel 3D20



Instruction Manual



Quick Start Guide



1 Filament Spool

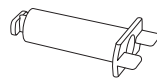

Spool Lock



Power Cable



USB Cable

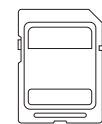

SD Card



Build Tape



Object Removal Tool



Unclog Tool



Leveling Sheet

**TIP:** Save your Dremel 3D20 packaging for future transportation and storage.

# 3

## Getting to Know Your Dremel 3D20

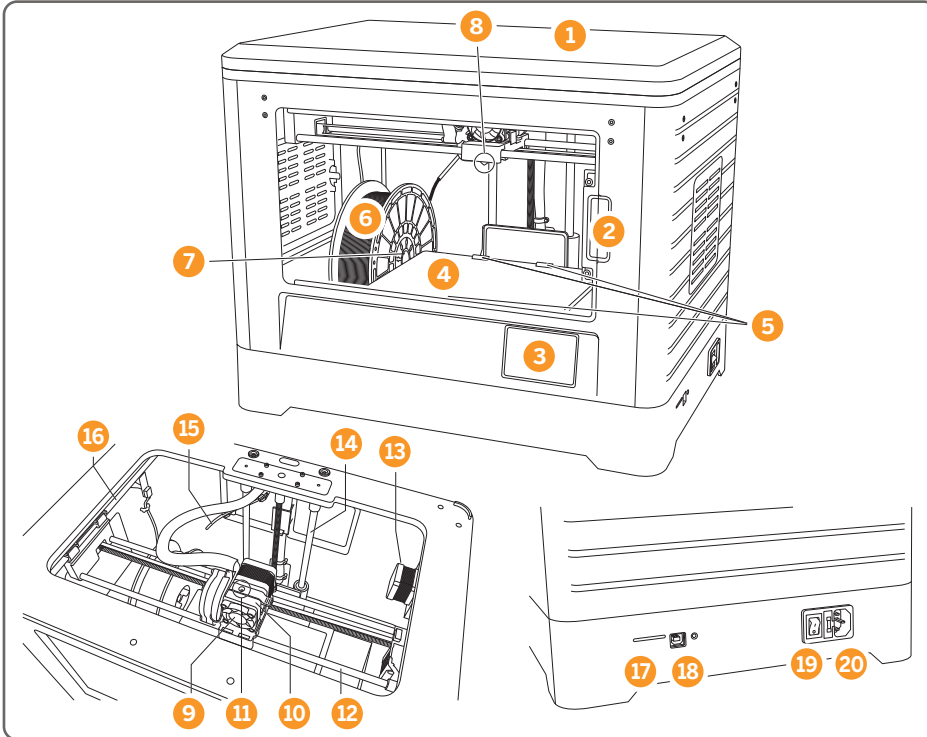

1. Lid
2. Door
3. Touch Screen
4. Build Platform
5. Build Platform Clips
6. Filament Spool
7. Filament Spool Holder/Lock
8. Extruder Tip
9. Extruder Fan
10. Extruder
11. Extruder Intake
12. X-Axis Guide Rails
13. Stepper Motor (1 of 3)
14. Z-Axis Guide Rail
15. Filament Guide Tube
16. Y-Axis Guide Rails
17. SD Card Input
18. USB Input
19. Power Switch
20. Power Input

# 4

## Getting Ready to Build

### **⚠ WARNING** OBSERVE ALL PROVIDED WARNINGS AND SAFETY INSTRUCTIONS WHEN USING THE DREMEL 3D20.

FAILURE TO DO SO MAY RESULT IN FIRE, EQUIPMENT DAMAGE, PROPERTY DAMAGE OR PERSONAL INJURY.

### FILAMENT INSTALLATION

1. Ensure the power switch is in the off position, remove the lid and remove the build platform.
2. Place filament spool onto spool holder with spool being fed from the bottom towards the back of the Dremel 3D20. Insert spool lock into spool holder and rotate 90 degrees to lock in place.
3. Thread filament through filament guide tube.
4. Insert the filament coming from the filament guide tube into the extruder intake (top).
5. Adhere build tape over the build platform.
6. Install platform using 3 clips. Place the table under the two back clips then snap it in with the front clip.
7. Plug power cord into outlet and turn on power switch.
8. Tap “Tools” on your Dremel 3D20’s touch screen, then tap “Filament”, then tap “Load Filament” and wait for the extruder to heat.
9. Once heated, filament will be drawn through the extruder. Allow filament to exit the extruder for 10 seconds before tapping the return arrow to complete.

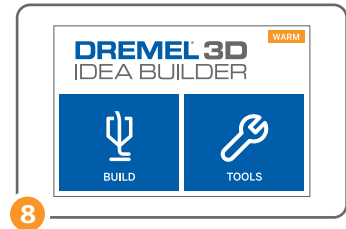
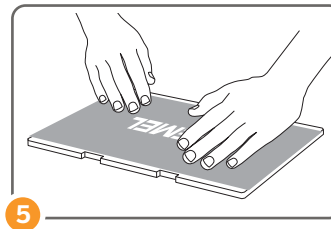
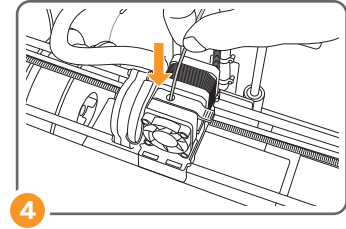
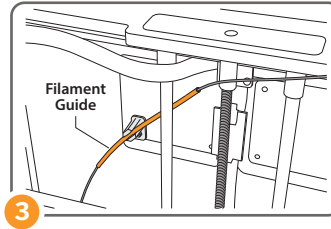
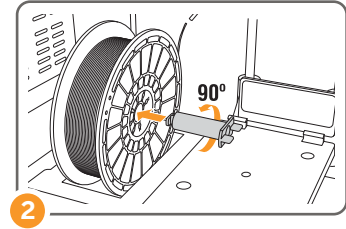
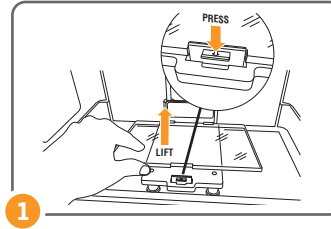

# 5

## Getting Ready to Build (continued...)

### LEVELING BUILD PLATFORM

1. Tap “Tools” on your Dremel 3D20’s touch screen and tap “Level”.
2. First level the front left of the build platform.
3. Place the leveling sheet between the extruder and build platform.
  - a) If the leveling sheet cannot slide between the extruder and build platform, turn the knob counterclockwise until you can slide the leveling sheet between the extruder and build platform with some resistance.
  - b) If the leveling sheet can slide between the extruder and build platform too easily, turn the knob clockwise until you can slide the leveling sheet between the extruder and build platform with some resistance.
4. Tap “Next” to move the build platform toward the right knob and repeat step above.
5. Tap “Next” to move the build platform toward the rear knob and repeat step above.
6. Tap “Finish” to complete the leveling process.

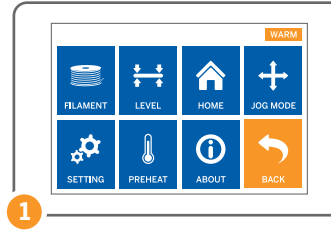

1

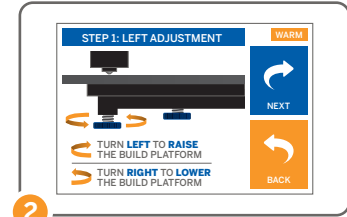

2

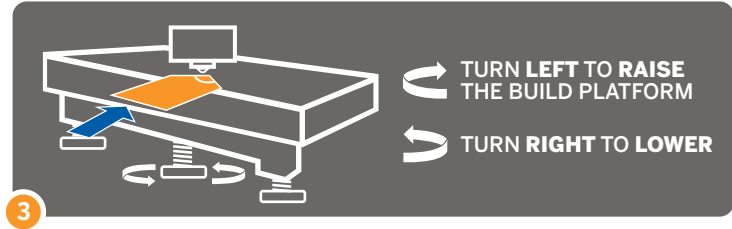

3

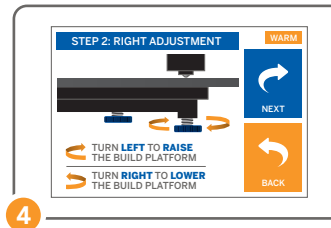

4

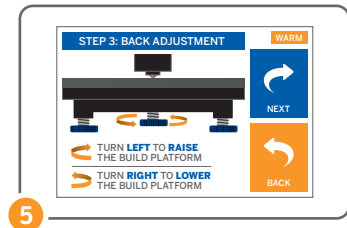

5

# 6

## Building

### BUILDING OUT OF THE BOX

1. On the main screen, tap the "Build" option. Then tap the machine icon to select from pre-installed models.
2. Tap on the model file you would like to build and tap "Build".
3. Your Dremel 3D20 will align the extruder with the build platform and will begin heating the extruder.
4. Once the build temperature is reached, your model will begin to build.
5. Touch screen will display "Object Finished". Tap the check box to confirm. Wait until the touch screen indicates that the extruder temperature is "COOL".

### REMOVING YOUR OBJECT FROM THE BUILD PLATFORM

6. Wait for the extruder to cool before removing your object.
7. With the object still attached, remove build platform from the build area.
8. Use your hand to peel your object from the build platform. If needed, gently use the object removal tool to remove object from build platform.

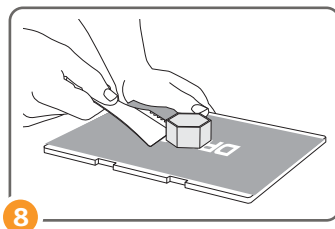
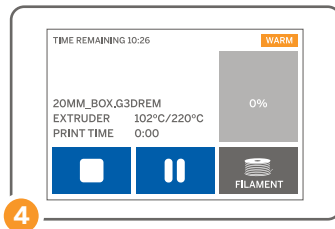
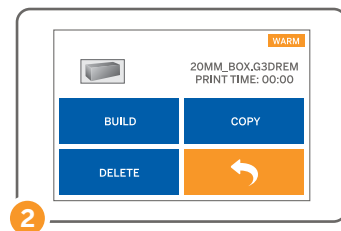

# 7

## Best Practices & Resources

### BEST PRACTICES

1. ALWAYS USE BUILD TAPE.
2. Ensure your platform is level (before you begin building your object).
3. Ensure spool is installed properly and can rotate freely.
4. When loading filament, allow Dremel 3D20 to extrude until material is consistent with the installed filament color.
5. It is important to stay near your Dremel 3D20 during operation and watch the Dremel 3D20 begin building objects. (If a situation occurs, select the STOP icon right away, to stop any further building).
6. Remove the build platform before removing the object.
7. Use object removal tool gently to avoid damaging the build platform or object.

### OPERATING ENVIRONMENT

Room Temperature: 16-29° C (60 - 85° F)

Level workspace

Dry workspace environment

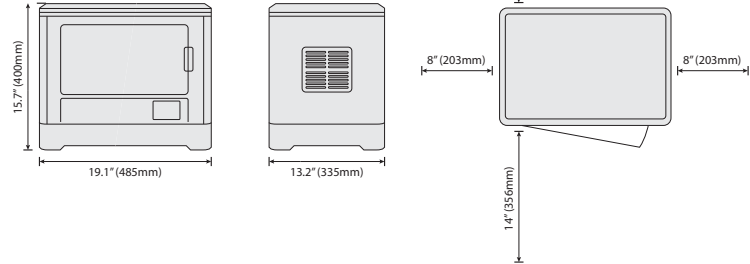

### 3D20 RESOURCES

Quick Start Guide	In box and <a href="http://www.dremel3d.com">www.dremel3d.com</a>
3D20 Website	<a href="http://www.dremel3d.com">www.dremel3d.com</a>
3D20 Customer Support	1-844-4DRML3D (1-844-437-6533) <a href="http://www.dremel3d.com">www.dremel3d.com</a>
Dremel 3D20 Software	Installed from <a href="http://www.dremel3d.com">www.dremel3d.com</a> or from SD card provided with the Dremel 3D20

## GETTING STARTED

1. Visit Dremel3D.com and create a profile.
2. Register your Idea Builder to gain access to all available models and support from the Dremel Experts.
3. Go to the Dremel3D.com Support section to download the Dremel 3D software.
4. Review the Dremel 3D Quick Start Guide online to watch videos on how to easily set up your Idea Builder.

## KICKSTART YOUR 3D PRINTING EXPERIENCE

- Once you have built the Dremel 3D test print located on your Idea Builder, verifying that your printer is set up properly, consider printing something more personalized.
- Visit the Design Tools section of Dremel3D.com to add your name or personal details to an existing model with a Dremel 3D customizer.
- Ready to design something from scratch? Try other free design tools developed by Autodesk including TinkerCad, Meshmixer, 123D Design, or 123D Sculpt.

**Build on Dremel Maker, Build on.**

